



HP Slate User Guide

© Copyright 2010 Hewlett-Packard
Development Company, L.P.

Bluetooth is a trademark owned by its proprietor and used by Hewlett-Packard Company under license. DuoSense is a registered trademark of N-trig Ltd. Microsoft and Windows are U.S. registered trademarks of Microsoft Corporation. SD Logo is a trademark of its proprietor.

The information contained herein is subject to change without notice. The only warranties for HP products and services are set forth in the express warranty statements accompanying such products and services. Nothing herein should be construed as constituting an additional warranty. HP shall not be liable for technical or editorial errors or omissions contained herein.

First Edition: August 2010

Document Part Number: 624812-001

Product notice

This user guide describes features that are common to most models. Some features may not be available on your Slate.

To obtain the latest information in the *HP Slate User Guide*, go to the HP Web site at <http://www.hp.com/support>.

Safety warning notice

-
- ⚠ **WARNING!** To reduce the possibility of heat-related injuries or of overheating the Slate, do not place the Slate directly on your lap. Use the Slate only on a hard, flat surface. Do not allow another hard surface, such as an adjoining optional printer, or a soft surface, such as pillows or rugs or clothing, to block airflow. Also, do not allow the AC adapter to contact the skin or a soft surface, such as pillows or rugs or clothing, during operation. The Slate and the AC adapter comply with the user-accessible surface temperature limits defined by the International Standard for Safety of Information Technology Equipment (IEC 60950).
-

Table of contents

1 Getting started	1
Finding more information about your new Slate	2
Using the touch screen, on-screen keyboard, and digital pen	3
Tapping	3
Flicking	3
Dragging	3
Scrolling	4
Rotating	4
Pinching	5
Setting touch screen preferences	5
Using the on-screen keyboard	6
On-screen keyboard options	7
Using the digital pen	7
Changing your Slate's view	9
2 Knowing the parts	11
Identifying the hardware	11
Top-edge components	11
Bottom-edge components	12
Right-edge components	12
Opening the label tray	13
Left-edge components	14
Buttons	14
Display components	15
Rear components	16
Wireless antennas	16
Additional hardware components	17
Identifying the labels	17
3 Networking (select models only)	19
Creating a wireless connection	19
Identifying wireless and network icons	19
Using operating system controls	19
Using a WLAN	20

Connecting to an existing WLAN	20
Setting up a new WLAN	20
Protecting your WLAN	21
Roaming to another network	21
Using Bluetooth wireless devices	22
Bluetooth and Internet Connection Sharing (ICS)	22
4 Multimedia	23
Identifying your multimedia components	23
Audio	25
Adjusting the volume	25
Checking audio functions on the Slate	26
Cameras	27
5 Power management	28
Shutting down the Slate	28
Setting power options	28
Using power-saving states	28
Initiating and exiting Sleep	29
Initiating and exiting Hibernation	29
Using the power meter	30
Using power plans	30
Viewing the current power plan	30
Selecting a different power plan	30
Customizing power plans	31
Setting password protection on wakeup	31
Using battery power	31
Displaying the remaining battery charge	31
Maximizing battery discharge time	32
Managing low battery levels	32
Identifying low battery levels	32
Resolving a low battery level	32
Resolving a low battery level when external power is available	32
Resolving a low battery level when no power source is available	32
Resolving a low battery level when the Slate cannot exit Hibernation	32
Conserving battery power	33
Using external AC power	33
Connecting the AC adapter	33
Docking the Slate to the HP Slate Dock	35
6 External cards and devices	36
Using SD Card Reader cards	36

Inserting a digital card	36
Removing a digital card	37
Using a USB device	37
Connecting a USB device	37
Removing a USB device	38
7 Drives	39
Identifying installed drives	39
Handling optional external hard drives	39
Using optional external drives	40
Using optional external devices	40
8 Security	41
Protecting your Slate	41
Using passwords	42
Using antivirus software	43
Using firewall software	44
Installing critical updates	45
9 Updating software	46
Updating programs and drivers	47
10 BIOS Setup	48
Starting BIOS Setup	48
Using BIOS Setup	48
Changing the language of BIOS Setup	48
Navigating and selecting in BIOS Setup	49
Displaying system information	49
Restoring factory settings in BIOS Setup	50
Exiting BIOS Setup	50
Updating the BIOS	51
Determining the BIOS version	51
Downloading a BIOS update	51
BIOS Setup Menu	52
Main menu	52
Diagnostics menu	53
System Configuration menu	53
Index	54

1 Getting started

Your Slate's main operating system is Microsoft® Windows® 7 Professional. The Microsoft Windows operating system displays the desktop on the display and controls your Slate's hardware, peripherals, and software programs.

Finding more information about your new Slate

The following user guides and reference material are provided with your Slate, either in print or on the Slate hard drive:

- *Quick Setup* poster—Guides you through setting up your Slate and turning it on. The poster is located in the box.



NOTE: Refer to the poster for the location of your user guides and reference material.

- *The Basics*—Contains information about your Slate, including product-specific features, backup and recovery, maintenance, and specifications.
- Help and Support—Contains information about the operating system, drivers, troubleshooting tools, and technical support. To access Help and Support, tap **Start > Help and Support**. For HP Slate-specific information, go to <http://www.hp.com/support>, select your country or region, and follow the on-screen instructions.
- *Safety & Comfort Guide*—Describes proper workstation setup and proper posture, health, and work habits for computer users. It also provides important electrical and mechanical safety information. To access this guide, tap **Start > All Programs > HP > HP Documentation**. This guide is also available on the Web at <http://www.hp.com/ergo>.
- *Regulatory, Safety, and Environmental Notices*—Contains safety and regulatory information, and battery disposal information. To access the notices, tap **Start > All Programs > HP > HP Documentation**.

Using the touch screen, on-screen keyboard, and digital pen

You can use your fingers to perform most actions on the touch screen.

 **NOTE:** The instructions in this section are based on the preferences set at the factory. To modify settings for recognized taps and flicks, refer to “Setting touch screen preferences.”

NOTE: Some gestures are not supported in all programs.

Tapping

Tap or double-tap an item on the screen as you would click or double-click with an external mouse. Tap and hold an item to see the context menu.

 **NOTE:** You must tap and hold your finger until the operating system draws a circle around the area you are touching, and then the context menu appears.

Flicking

Touch the screen in a light, quick flicking motion up, down, left, or right to navigate through screens or quickly scroll through documents.

 **NOTE:** For the flick movement to work, a scrollbar must be present in the active window.

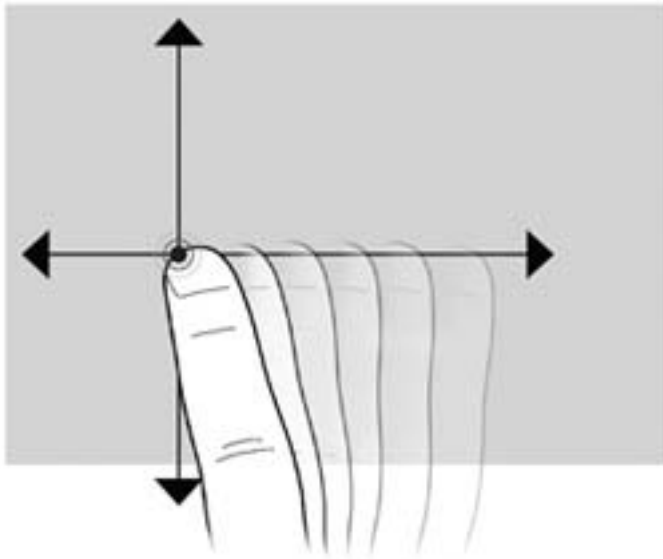

Dragging

Press your finger on an item on the screen, and then move your finger to drag the item to a new location. You can also use this motion to slowly scroll through documents.

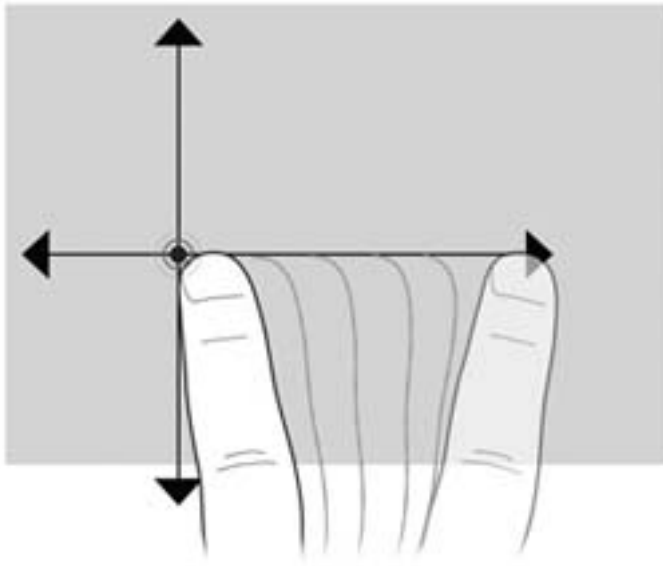

Scrolling

Scrolling is useful for moving up and down or left and right on a page or image. To scroll, place two fingers slightly apart on the screen, and then drag them across the screen in an up, down, left, or right motion.

 **NOTE:** Scrolling speed is controlled by finger speed.

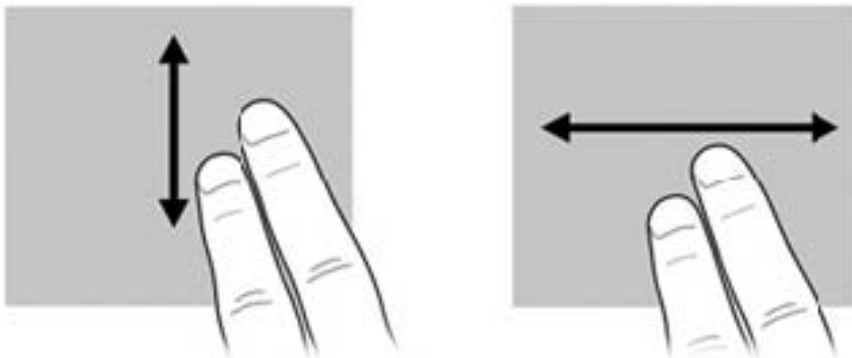

Rotating

Rotating allows you to rotate items such as photos and pages. To rotate, anchor your thumb on the screen, and then move your forefinger in a semicircular motion around your thumb.

 **NOTE:** You must move your forefinger for at least 90 degrees of a circle.

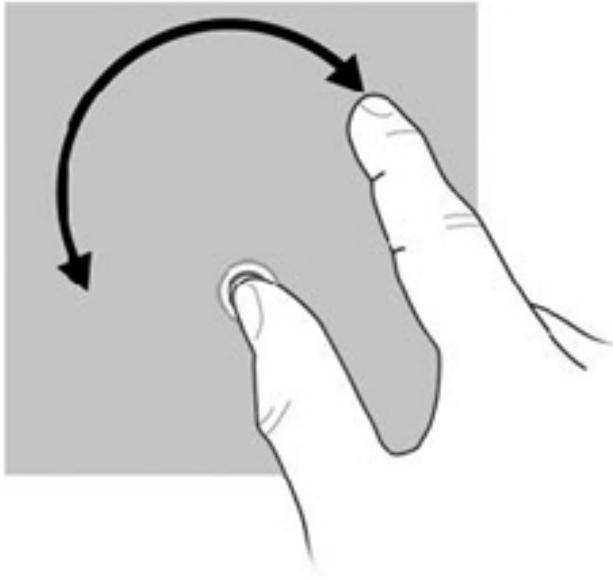

Pinching

Pinching allows you to zoom in or out on items such as PDFs, images, and photos.

To pinch:

- Zoom out by holding two fingers apart on the screen, and then pull the fingers together to decrease an object's size.
- Zoom in by holding two fingers together on the screen, and then pull the fingers apart to increase an object's size.

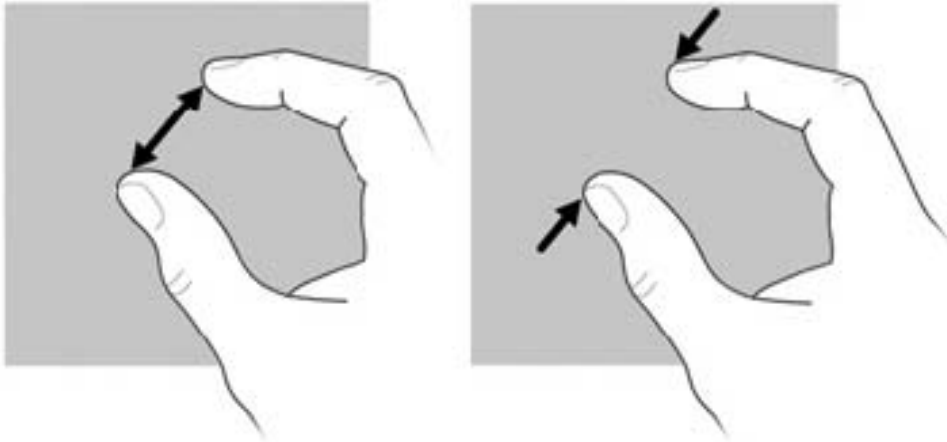

Setting touch screen preferences

To change or test tap settings:

1. Tap **Start > Control Panel**.
2. Tap **Hardware and Sound > N-trig DuoSense™ Digitizer Settings > Digitizer options** tab, and then follow the on-screen instructions.

These preferences are specific to the touch screen and the Slate.

To change or create flick assignments:

1. Tap **Start > Control Panel**.
2. Tap **Hardware and Sound > Pen and Touch > Flicks** tab.
3. Tap **Navigational flicks and editing flicks**, and then tap **Customize**.
4. Follow the on-screen instructions to change or create a flick assignment.
5. Tap **OK**.

Using the on-screen keyboard

Occasionally you may need to enter data into a data field. This may be required when you set up a wireless network configuration or a weather reporting location, or when you access user accounts on Internet sites. Your Slate has an on-screen keyboard that is displayed when you need to enter such information into data fields.



1. To display the keyboard, tap in the first data field. Tap the small keyboard icon that is displayed.
– or –
Double-tap the keyboard icon at the left side of the screen.
– or –
Press the Keyboard button on the left edge of the Slate.
2. To enlarge the size of the on-screen keyboard, tap the lower-right corner and drag it to the desired size.
3. Tap each character, continuing until you have spelled out the name or word that you are entering into the data field.

 **NOTE:** Suggested words may be displayed at the top of the keyboard. If an appropriate word is displayed, tap it to select it.

4. Tap **enter** on the keyboard.

On-screen keyboard options

To select options for the on-screen keyboard, tap **Tools** at the top of the keyboard, and then select one of the following options:

- **Show expanded keyboard**—Displays the expanded keyboard.



- **Docking**—Allows you to select the location where the on-screen keyboard displays.
 - **Float**—Allows you to reposition the on-screen keyboard by tapping the top of the keyboard window and dragging it to the desired location.
 - **Dock at top of screen**—Displays the keyboard at the top of the screen automatically.
 - **Dock at bottom of screen**—Displays the keyboard at the bottom of the screen automatically.
- **Help topics**—Displays Help and Support.
- **Options**—Displays the Input Panel Options.

Using the digital pen

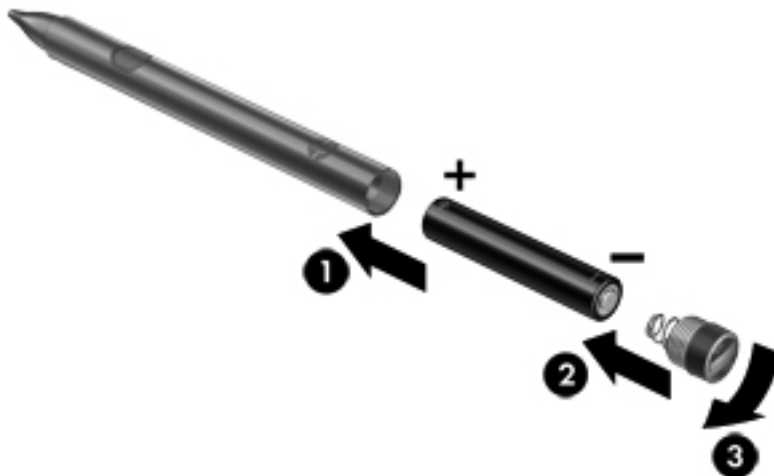

To insert the battery in the pen:

1. Unscrew the cap from the pen.
2. Insert the battery (1) in the pen.

3. Replace the cap **(2)** on the pen.
4. Turn the cap in a clockwise direction **(3)** to tighten it.

The digital pen is now ready to use with your HP Slate. Simply touch the tip of the pen lightly on the screen to write text or select items on the screen. To perform a right-click action, press the button on the side of the pen when selecting an item on the screen.

The digital pen uses inherent pressure sensitivity, so you can create a bolder stroke by pressing harder on the screen with the digital pen. Pressure sensitivity may not be enabled in all programs.

To calibrate the pen and change pen settings, such as pen sensitivity, tap **Start > Control Panel > Hardware and Sound > N-trig DuoSense Digitizer Settings**, and then follow the on-screen instructions.

 **NOTE:** For regulatory and safety information, refer to the *Regulatory, Safety, and Environmental Notices* on the HP Slate. Tap **Start > All Programs > HP > HP Documentation**.

Changing your Slate's view

Your Slate's orientation, or view, changes automatically from landscape to portrait view, or from portrait to landscape view.

1. To change the view of your Slate from landscape view to portrait view:

Hold the Slate vertically, and then turn it 90 degrees to the right (in a clockwise direction).

2. To change the view of your Slate from portrait view to landscape view:

Hold the Slate vertically, and then turn it 90 degrees to the left (in a counter-clockwise direction).

 **NOTE:** The appearance of the desktop may vary.

Description**View**

Landscape

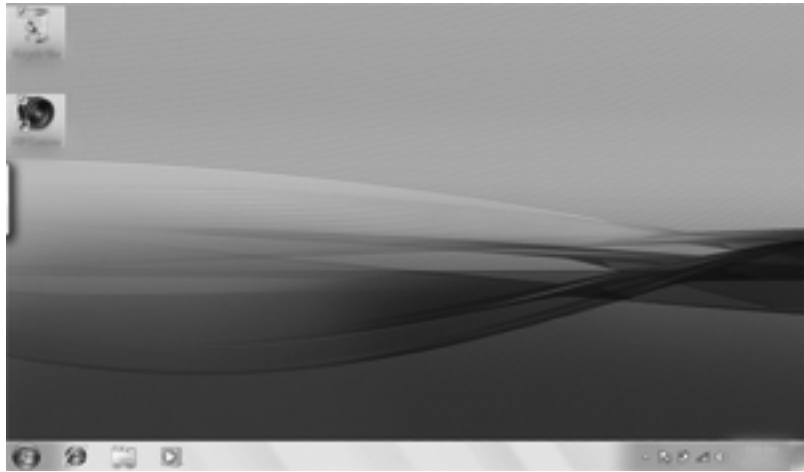

Portrait



2 Knowing the parts

Identifying the hardware

Components included with the Slate may vary by region and model. The illustrations in this chapter identify the standard features on most Slate models.





To see a list of hardware installed in the Slate:

1. Tap **Start > Control Panel**.
2. Tap **System and Security**, tap **System**, and then tap **Device Manager**.

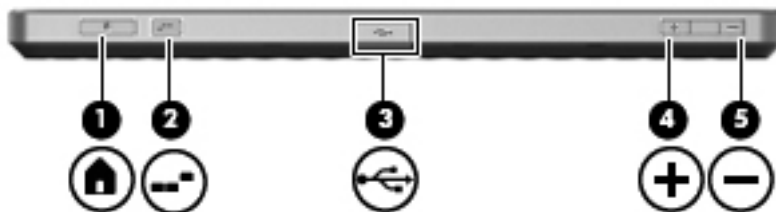
You can also add hardware or modify Slate configurations using Device Manager.

Top-edge components



Component	Description
(1)  Home button	Minimizes all open applications and displays the Windows desktop.
(2)  Ctrl+alt+del button	Performs the same action as pressing <code>ctrl+alt+del</code> on a computer keyboard.
(3)  USB port	Connects optional USB devices. NOTE: To use an external optical disc drive connected to the Slate, you must connect AC power separately to the external drive.
(4)  Volume up button	Increases speaker volume.
(5)  Volume down button	Decreases speaker volume.

Bottom-edge components

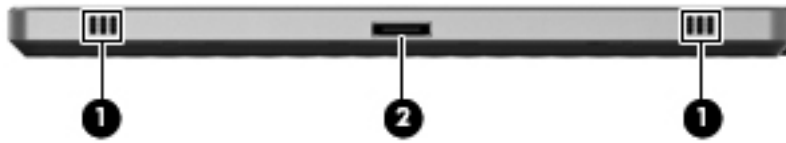

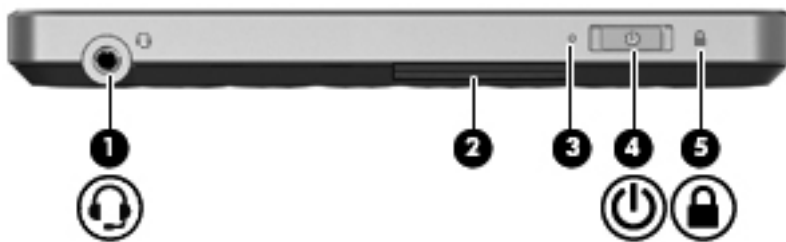

Component		Description
(1)	Speakers (2)	Produce sound.
(2)	Power connector	Connects an AC adapter or an HP Slate Dock.

Right-edge components



Component		Description
(1)	 Audio-out (headphone)/Audio-in (microphone) combo jack	Produces sound when connected to optional powered stereo speakers, headphones, earbuds, a headset, or television audio. Also connects an optional headset microphone. NOTE: When an audio component is connected to the jack, the Slate's speakers are disabled. The audio component cable must have a 4-conductor connector.
(2)	Label tray	Holds the serial number label.
(3)	Power light	<ul style="list-style-type: none"> White: The Slate is on. Blinking: The Slate is in the Sleep state. Off: The Slate is off or in Hibernation.

Component	Description
(4)  Power switch	<ul style="list-style-type: none"> • When the Slate is off, slide the switch down to turn on the Slate. • When the Slate is on, briefly slide the switch down to initiate Sleep. • When the Slate is in the Sleep state, briefly slide the switch down to exit Sleep. • When the Slate is in Hibernation, briefly slide the switch down to exit Hibernation. <p>If the Slate has stopped responding and Windows shutdown procedures are ineffective, slide and hold the power switch down for at least five seconds to turn off the Slate.</p> <p>To learn more about your power settings, tap Start > Control Panel > System and Security > Power Options.</p>
(5)  PowerLock icon	<p>The PowerLock feature allows you to lock the screen to avoid accidental activation:</p> <ul style="list-style-type: none"> • When the Slate is on, slide the power switch up to the lock position to lock the screen, buttons, and the auto-rotate feature.

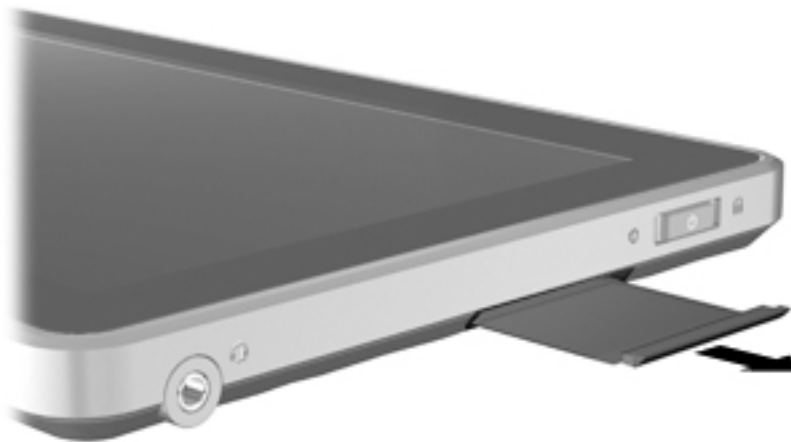

Opening the label tray

Pull the label tray out to view the serial number label.





Left-edge components





Component	Description
(1) 	Internal microphone Records sound.
(2) 	Keyboard button When the Slate is on, press the button to display the on-screen keyboard.
(3) 	SD Card Reader Supports the following optional digital card formats: <ul style="list-style-type: none"> Secure Digital High Capacity (SDHC) Memory Card (standard and large size) xD-Picture card

Buttons



Component	Description
(1) 	Home button When the Slate is on, press the button to minimize all open applications and display the Windows desktop.
(2) 	Ctrl+alt+del button Performs the same action as pressing <code>ctrl+alt+del</code> on a computer keyboard.
(3) 	Volume up button <ul style="list-style-type: none"> Press + to increase speaker volume.

Component		Description
(3)		Volume down button <ul style="list-style-type: none"> Press - to decrease speaker volume.
(4)		Keyboard button <p>When the Slate is on, press the button to display the on-screen keyboard.</p>

Display components



Component		Description
(1)	Inward camera	Records video and captures still photographs.

Rear components

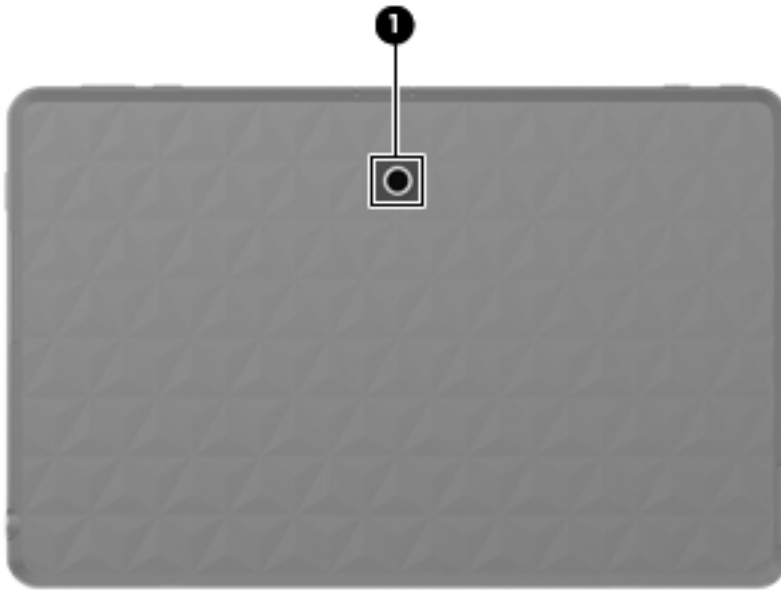

Component	Description
(1) Outward camera	Records video and captures still photographs.

Wireless antennas



Component	Description
WLAN antennas (2)*	Send and receive wireless signals to communicate with wireless local-area networks (WLANs).

*The antennas are not visible from the outside of the Slate. For optimal transmission, keep the areas immediately around the antennas free from obstructions.

To see wireless regulatory notices, refer to the section of the *Regulatory, Safety, and Environmental Notices* that applies to your country or region. Tap **Start > All Programs > HP > HP Documentation**.

Additional hardware components



Component	Description
(1) 30W AC adapter*	Converts AC power to DC power.
(2) Power cord*	Connects an AC adapter to an AC outlet.

*AC adapters and power cords vary in rating and appearance by region and country.

Identifying the labels

The labels affixed to the label tray of the Slate provide information you may need when you troubleshoot system problems or travel internationally with the Slate.

- Serial number label (part of the Master Regulatory label)—Provides important information including the following:

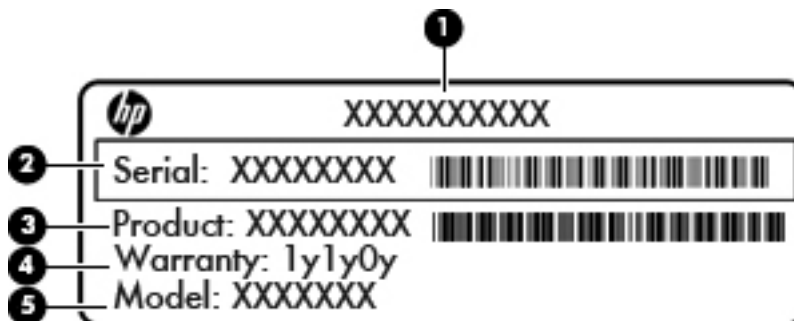

- Product name (1). This is the product name affixed to the front of your Slate.
- Serial number (2). This is an alphanumeric identifier that is unique to each product.
- Product number (3). This is an alphanumeric identifier that provides specific information about the hardware components. The product number helps a service technician to determine what components and parts are needed.

- Warranty period **(4)**. This number describes the duration (in years) of the warranty period for this Slate.
- Model description (select models) **(5)**. This is an alphanumeric identifier that you use to locate documents, drivers, and support for your Slate.

Have this information available when you contact technical support. The serial number label is located inside the label tray of your Slate.

- Microsoft® Certificate of Authenticity—Contains the Windows® Product Key. You may need the Product Key to update or troubleshoot the operating system. This certificate is located inside the label tray.
- Regulatory label—Provides regulatory information about the Slate. The regulatory marks are located on the top or the bottom of the label tray.
- Wireless certification label(s)—Provide certification information about wireless devices, such as a wireless local area network (WLAN) device or a Bluetooth® device, and the approval markings of some of the countries or regions in which the devices have been approved for use. You may need this information when traveling internationally. Wireless certification labels are affixed inside the label tray.

3 Networking (select models only)

Your Slate supports wireless Internet access. For mobile Internet access, you can use a wireless connection.



Creating a wireless connection

Your Slate may be equipped with one or more of the following wireless devices:

- Wireless local area network (WLAN) device
- Bluetooth® device

For more information on wireless technology, refer to the information and Web site links provided in Help and Support.

Identifying wireless and network icons

Icon	Name	Description
	Network (connected)	Indicates that one or more network devices are connected to a network.
	Network (disconnected)	Indicates that network devices are not connected to a network.
	Network (disabled/ disconnected)	Indicates that no wireless connections are available.

Using operating system controls

The Network and Sharing Center allows you to set up a connection or network, connect to a network, manage wireless networks, and diagnose and repair network problems.

▲ Tap **Start > Control Panel > Network and Internet > Network and Sharing Center**.

For more information, tap **Start > Help and Support**.

Using a WLAN

A wireless connection connects the Slate to Wi-Fi networks, or WLANs. A WLAN is composed of other computers and accessories that are linked by a wireless router or a wireless access point.

Connecting to an existing WLAN

To connect to the WLAN, follow these steps:

1. Be sure that the WLAN device is on.
2. Tap the **Wireless** icon in the notification area, at the far right of the taskbar.
3. Tap your WLAN from the list.
4. Tap **Connect**.

If the network is a security-enabled WLAN, you are prompted to enter a network security key, which is a security code. Type the code, and then tap **OK** to complete the connection.

 **NOTE:** If no WLANs are listed, you are out of range of a wireless router or access point.

NOTE: If you do not see the network you want to connect to, tap **Open Network and Sharing Center**, and then tap **Set up a new connection or network**. A list of options is displayed. You can choose to manually search for and connect to a network or to set up a new network connection.

After the connection is made, place the pointer over the network icon in the notification area, at the far right of the taskbar, to verify the name and status of the connection.

 **NOTE:** The functional range (how far your wireless signals travel) depends on WLAN implementation, router manufacturer, and interference from other electronic devices or structural barriers such as walls and floors.

Setting up a new WLAN

Required equipment:

- A broadband modem (either DSL or cable) **(1)** and high-speed Internet service purchased from an Internet service provider (ISP)
- A wireless router (purchased separately) **(2)**

 **NOTE:** Some cable modems include a built-in router. Check with your ISP to see if you need a separate router.

- Slate equipped with a wireless device **(3)**

The following illustration shows an example of a wireless network installation that is connected to the Internet.

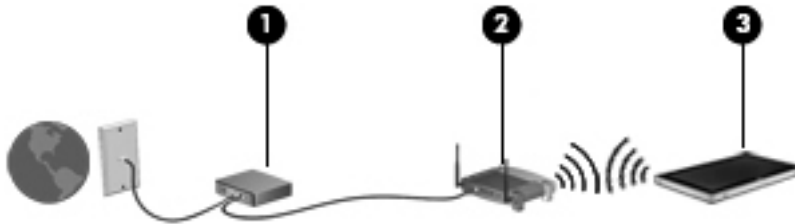

NOTE: When setting up a wireless connection, be sure that your Slate and wireless router are synchronized. To synchronize your Slate and wireless router, turn your Slate and wireless router off and then back on.

As your network grows, additional wireless and wired devices can be connected to the network to access the Internet.

For help in setting up your WLAN, refer to the information provided by your router manufacturer or your ISP.

Protecting your WLAN

When you set up a WLAN or access an existing WLAN, always enable security features to protect your network from unauthorized access. WLANs in public areas (hotspots) like coffee shops and airports may not provide any security. If you are concerned about the security of your Slate in a hotspot, limit your network activities to e-mail that is not confidential and basic Internet surfing.

Wireless radio signals can travel outside the network, so other WLAN devices can pick up unprotected signals and either connect to your network (uninvited) or capture information being sent across it. You can take the following precautions to protect your WLAN:

- **Firewall**—A firewall checks both data and requests for data that are sent to your network, and discards any suspicious items. Firewalls are available in both software and hardware. Some networks use a combination of both types.
- **Wireless encryption**—Wi-Fi Protected Access (WPA) uses security settings to encrypt and decrypt data transmitted over the network. WPA uses Temporal Key Integrity Protocol (TKIP) to dynamically generate a new key for every packet. It also generates different sets of keys for each computer on the network.

Roaming to another network

When you move your Slate within range of another WLAN, Windows attempts to connect to that network. If the attempt is successful, your Slate is automatically connected to the new network. If Windows does not recognize the new network, follow the same procedure you used initially to connect to your WLAN.

Using Bluetooth wireless devices

A Bluetooth device provides short-range wireless communications that replace the physical cable connections that traditionally link electronic devices such as the following:

- Computers
- Phones
- Imaging devices (cameras and printers)
- Audio devices

Bluetooth devices provide peer-to-peer capability that allows you to set up a personal area network (PAN) of Bluetooth devices. For information on configuring and using Bluetooth devices, refer to the Bluetooth software Help.

- ▲ To connect a Bluetooth device, tap the **Bluetooth** icon in the navigation area, at the far right of the taskbar, tap **Bluetooth Options**, and then follow the on-screen instructions.

Bluetooth and Internet Connection Sharing (ICS)

HP does **not** recommend setting up one computer with Bluetooth as a host and using it as a gateway through which other computers may connect to the Internet. When two or more computers are connected using Bluetooth, and Internet Connection Sharing (ICS) is enabled on one of the computers, the other computers may not be able to connect to the Internet using the Bluetooth network.

The strength of Bluetooth is in synchronizing information transfers between your Slate and wireless devices including cellular phones, printers, cameras, and PDAs. The inability to consistently connect two or more computers to share the Internet through Bluetooth is a limitation of Bluetooth and the Windows operating system.

4 Multimedia

Your Slate may include the following:

- Integrated speakers
- Integrated microphone
- Integrated cameras
- Preinstalled multimedia software

Identifying your multimedia components

The following illustration and table describe the multimedia features of the Slate.

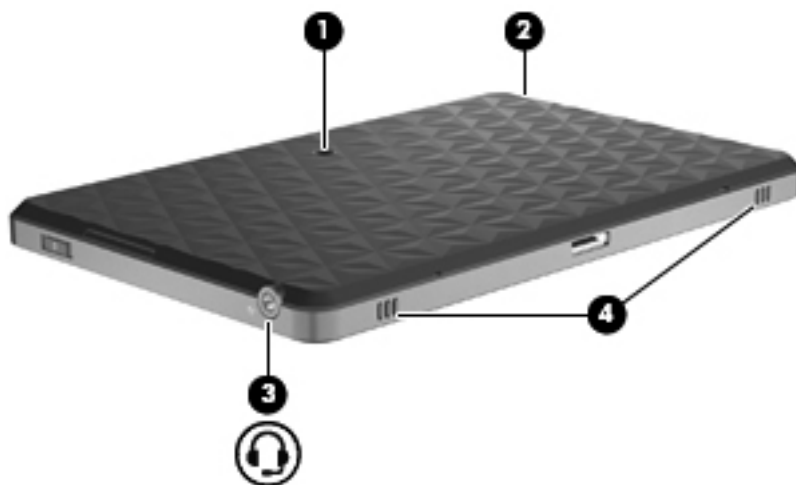

Component	Description
(1) Outward camera	Records video and captures still photographs. NOTE: To capture still photos and record video, you can use the HP Slate Camera software. Tap the Outward button to use the outward camera.
(2) Inward camera	Records video and captures still photographs. NOTE: To capture still photos and record video, you can use the HP Slate Camera software. Tap the Inward button to use the inward camera.

Component	Description
(3) Audio-out (headphone)/Audio-in (microphone) combo jack	<p data-bbox="863 216 1401 327">Produces sound when connected to optional powered stereo speakers, headphones, earbuds, a headset, or television audio. Also connects an optional headset microphone.</p> <p data-bbox="863 348 1401 407">NOTE: When an audio component is connected to the jack, the Slate's speakers are disabled.</p> <p data-bbox="863 428 1401 478">The audio component cable must have a 4-conductor connector.</p>
(4) Speakers (2)	Produce sound.

Audio

Your Slate has a variety of audio features that allow you to:

- Play music using your Slate's speakers and/or connected external speakers.
- Record sound using the internal microphone or an optional external headset microphone.
- Download music from the Internet.
- Create multimedia slideshows and presentations using audio and images.
- Transmit sound and images with instant messaging programs.

Adjusting the volume

⚠ **WARNING!** To reduce the risk of personal injury, adjust the volume before putting on headphones, earbuds, or a headset. For additional safety information, refer to the *Regulatory, Safety, and Environmental Notices*.

You can adjust the volume using the following volume controls:

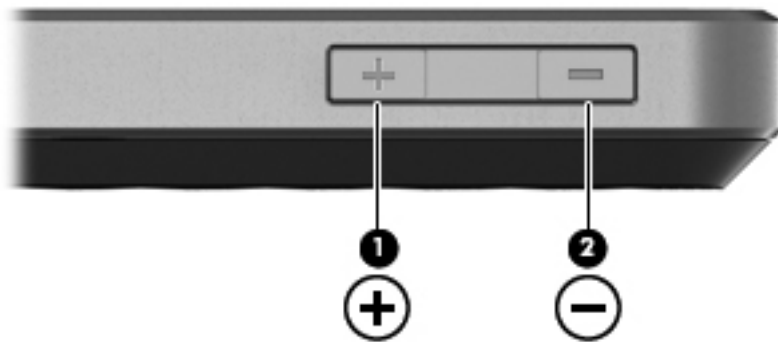

- To increase volume, press the Volume up button (1) on the top edge of the Slate.
- To decrease volume, press the Volume down button (2) on the top edge of the Slate.
- Windows® volume control:
 - a. Tap the **Speakers** icon in the notification area, and then tap **Open Volume Mixer**.
 - b. In the Speakers column, increase or decrease the volume by moving the slider up or down. You can also mute the volume by tapping the **Mute Speakers** icon.

If the Speakers icon is not displayed in the notification area, follow these steps to add it:

- a. Tap and hold the **Show hidden icons** icon (the arrow at the far left of the notification area).
 - b. Tap **Customize**.
 - c. Under **Behaviors**, tap **Show icon and notifications** for the Speakers icon.
 - d. Tap **OK**.
- Program volume control:

Volume can also be adjusted within some programs.

Checking audio functions on the Slate

To check the audio functions on your Slate, follow these steps:

1. Tap **Start > Control Panel**.
2. Tap **Hardware and Sound**, and then tap **Sound**.
3. When the Sound window opens, tap the **Sounds** tab. Under **Program Events**, tap any sound event, such as a beep or alarm, and then tap the **Test** button.

You should hear sound through the speakers or through connected headphones.

To check the record functions of the Slate, follow these steps:

1. Tap **Start > All Programs > Accessories > Sound Recorder**.
2. Tap **Start Recording** and speak into the microphone. Save the file to your desktop.
3. Open a multimedia program and play back the sound.

 **NOTE:** For best results when recording, speak directly into the microphone and record sound in a setting free of background noise.

To confirm or change the audio settings:

1. Tap **Start > Control Panel**.
2. Tap **Hardware and Sound**, and then tap **Sound**.

Cameras

Your Slate includes an outward integrated camera and an inward integrated camera. The cameras are input devices that allow you to record video and capture still photographs.

 **NOTE:** For more information, refer to the HP Slate Camera software Help.

5 Power management

Shutting down the Slate

△ **CAUTION:** Unsaved information will be lost when the Slate is shut down.

The Shut down command closes all open programs, including the operating system, and then turns off the display and Slate.

Shut down the Slate when the Slate is unused and disconnected from external power for an extended period.

Although you can shut down the Slate with the power switch, the recommended procedure is to use the Windows Shut down command.

To shut down the Slate, follow these steps:

📄 **NOTE:** If the Slate is in the Sleep state or in Hibernation, you must first exit Sleep or Hibernation before shut down is possible.

1. Save your work and close all open programs.
2. Tap **Start**.
3. Tap **Shut down**.

If the Slate is unresponsive and you are unable to use the preceding shut down procedures, try the following emergency procedures in the sequence provided:

- Press the Ctrl+alt+del button on the top edge of the Slate, next to the Home button, and then slide the power switch down.
- Slide and hold the power switch down for at least 5 seconds.
- Disconnect the Slate from external power.

Setting power options

Using power-saving states

The Slate has two power-saving states enabled at the factory: Sleep and Hibernation.

When Sleep is initiated, the screen clears. Your work is saved to memory, letting you exit the Sleep state faster than exiting Hibernation. If the Slate is in the Sleep state for an extended period or if the battery reaches a critical battery level while in the Sleep state, the Slate initiates Hibernation.

When Hibernation is initiated, your work is saved to a hibernation file on the hard drive and the Slate turns off.

△ **CAUTION:** To prevent possible audio and video degradation, loss of audio or video playback functionality, or loss of information, do not initiate Sleep or Hibernation while reading from or writing to a disc or an external media card.

📝 **NOTE:** You cannot initiate any type of networking connection or perform any Slate functions while the Slate is in the Sleep state or in Hibernation.

Initiating and exiting Sleep

The system is set at the factory to initiate Sleep after 10 minutes of inactivity when running on battery power and 20 minutes of inactivity when running on external power.

Power settings and timeouts can be changed using Power Options in Windows Control Panel.

With the Slate on, you can initiate Sleep in any of the following ways:

- Briefly slide the power switch down.
- Tap **Start**, tap the arrow next to the Shut down button, and then tap **Sleep**.

To exit Sleep:

- ▲ Briefly slide the power switch down.

When the Slate exits Sleep, your work returns to the screen where you stopped working.

📝 **NOTE:** If you have set a password to be required when the Slate exits Sleep, you must enter your Windows password before your work returns to the screen.

Initiating and exiting Hibernation

The system is set at the factory to initiate Hibernation after a period of inactivity when running on battery power or on external power, or when the battery reaches a critical battery level.

Power settings and timeouts can be changed using Power Options in Windows Control Panel.

To initiate Hibernation:

- ▲ Tap **Start**, tap the arrow next to the Shut down button, and then tap **Hibernate**.

To exit Hibernation:

- ▲ Briefly slide the power switch down.

When the Slate exits Hibernation, your work returns to the screen where you stopped working.

📝 **NOTE:** If you have set a password to be required when the Slate exits Hibernation, you must enter your Windows password before your work returns to the screen.

Using the power meter

The power meter is located in the notification area, at the far right of the taskbar. The power meter allows you to quickly access power settings, view remaining battery charge, and select a different power plan.

- To display the percentage of remaining battery charge and the current power plan, tap the Power Meter icon.
- To access Power Options, or to change the power plan, tap the **Power Meter** icon, and then select an item from the list.

Different power meter icons indicate whether the Slate is running on battery or external power. The icon also displays a message if the battery has reached a low battery level, critical battery level, or reserve battery level.

To hide or display the power meter icon:

1. Tap and hold the **Show hidden icons** icon (the arrow at the left side of the notification area).
2. Tap **Customize notification icons**.
3. Under **Behaviors**, select **Show icon and notifications** for the Power Meter icon.
4. Tap **OK**.

Using power plans

A power plan is a collection of system settings that manages how the Slate uses power. Power plans can help you conserve power and maximize Slate performance.

The following power plans are available:

- HP Recommended
- Power saver

You can change the settings of these power plans through Power Options.

Viewing the current power plan

- ▲ Tap the **Power Meter** icon in the notification area, and then tap **More power options**.

– or –

Tap **Start > Control Panel > System and Security > Power Options**.

Selecting a different power plan

1. Tap the **Power Meter** icon in the notification area, and then tap **More power options**.

– or –

Tap **Start > Control Panel > System and Security > Power Options**.

2. Select a power plan from the list.

Customizing power plans

1. Tap the **Power Meter** icon in the notification area, and then tap **More power options**.
– or –
Tap **Start > Control Panel > System and Security > Power Options**.
2. Tap a power plan, and then tap **Change plan settings**.
3. Change the settings as needed.
4. To change additional settings, tap **Change advanced power settings** and make your changes.

Setting password protection on wakeup

To set the Slate to prompt for a password when the Slate exits Sleep or Hibernation, follow these steps:

1. Tap the **Power Meter** icon in the notification area, and then tap **More power options**.
– or –
Tap **Start > Control Panel > System and Security > Power Options**.
2. In the left pane, tap **Require a password on wakeup**.
3. Tap **Change settings that are currently unavailable**.
4. Tap **Require a password (recommended)**.

 **NOTE:** If you need to create a user account password or change your current user account password, tap **Create or change your user account password**, and then follow the on-screen instructions. If you do not need to create or change a user account password, go to step 5.

5. Tap **Save changes**.

Using battery power

 **WARNING!** To reduce potential safety issues, use only the battery provided with the Slate.

The Slate runs on battery power whenever it is not plugged into external power. Slate battery life varies, depending on power management settings, running programs, display brightness, external devices connected to the Slate, and other factors.

If the Slate contains a charged battery and the Slate is running on external AC power supplied through the AC adapter, the Slate switches to battery power if the AC adapter is disconnected from the Slate.

 **NOTE:** When you disconnect AC power, the display brightness is automatically decreased to save battery life. For information on increasing or decreasing display brightness, refer to *The Basics* guide.

Displaying the remaining battery charge

- ▲ Move the pointer over the **Power Meter** icon in the notification area, at the far right of the taskbar.

Maximizing battery discharge time

Battery discharge time varies depending on the features you use while on battery power. Maximum discharge time gradually shortens, as the battery storage capacity naturally degrades.

Tips for maximizing battery discharge time:

- Decrease the brightness on the display.
- Store the Slate in a cool, dry location.
- Select the **Power saver** setting in Power Options.

Managing low battery levels

The information in this section describes the alerts and system responses set at the factory. Some low-battery alerts and system responses can be changed using Power Options in Windows Control Panel. Preferences set using Power Options do not affect lights.

Identifying low battery levels

The Slate takes the following actions for a critical battery level:

- If Hibernation is enabled and the Slate is on or in Sleep, the Slate initiates Hibernation.
- If Hibernation is disabled and the Slate is on or in Sleep, the Slate remains briefly in Sleep, and then shuts down and loses any unsaved information.

Resolving a low battery level

Resolving a low battery level when external power is available

Connect one of the following devices:

1. AC adapter
2. HP Slate Dock

Resolving a low battery level when no power source is available

- ▲ Initiate Hibernation.

– or –

Save your work and shut down the Slate.

Resolving a low battery level when the Slate cannot exit Hibernation

When the Slate lacks sufficient power to exit Hibernation, follow these steps:

1. Plug the Slate into external power.
2. Exit Hibernation by briefly sliding the power switch.

Conserving battery power

- Tap the **Power saver** power plan through Power Options under System and Security in Windows Control Panel.
- Turn off wireless and local area network (LAN) connections and exit modem applications when you are not using them.
- Disconnect unused external devices that are not plugged into an external power source.
- Stop, disable, or remove any external media cards that you are not using.
- Decrease screen brightness.
- Before you leave your work, initiate Sleep or Hibernation, or shut down the Slate.

Using external AC power

External AC power is supplied through an approved AC adapter or an HP Slate Dock.

⚠ **WARNING!** To reduce potential safety issues, use only the AC adapter provided with the Slate, a replacement AC adapter provided by HP, or a compatible AC adapter purchased from HP.

Connect the Slate to external AC power under any of the following conditions:

⚠ **WARNING!** Do not charge the battery while you are onboard aircraft.

- When charging or calibrating a battery
- When installing or modifying system software
- When writing information to an optional external drive
- When running Disk Defragmenter
- When performing a backup or recovery

When you connect the Slate to external AC power, the battery begins to charge.

When you disconnect external AC power, the Slate switches to battery power.

Connecting the AC adapter

⚠ **WARNING!** To reduce the risk of electric shock or damage to the equipment:

Plug the power cord into an AC outlet that is easily accessible at all times.

Disconnect power from the Slate by unplugging the power cord from the AC outlet (not by unplugging the power cord from the Slate).

If provided with a 3-pin attachment plug on the power cord, plug the cord into a grounded (earthed) 3-pin outlet. Do not disable the power cord grounding pin, for example, by attaching a 2-pin adapter. The grounding pin is an important safety feature.

To connect the Slate to external AC power, follow these steps:

1. Plug the AC adapter into the power connector **(1)** on the Slate.
2. Plug the power cord into the AC adapter **(2)**.

3. Plug the other end of the power cord into an AC outlet (3).

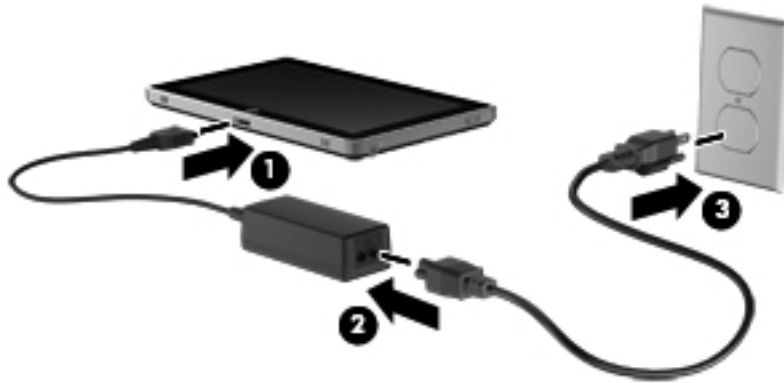

Docking the Slate to the HP Slate Dock

To dock the Slate to the HP Slate Dock, follow these steps:

1. Align the docking connector on the dock base with the power connector on the bottom edge of the Slate, and then lower the Slate onto the dock.
2. Plug the AC adapter into the power connector on the back of the dock.
3. Plug the power cord into the AC adapter.
4. Plug the other end of the power cord into an AC outlet.



6 External cards and devices

Using SD Card Reader cards

Optional digital cards provide secure data storage and convenient data sharing. These cards are often used with digital media–equipped cameras and PDAs as well as with other devices.

The SD Card Reader supports the following formats:

- Secure Digital High Capacity (SDHC) Memory Card (standard and large size)
- xD-Picture card

Inserting a digital card

△ **CAUTION:** To avoid damaging the digital card or the Slate, do not insert any type of adapter into the SD Card Reader.

CAUTION: To prevent damage to the digital card connectors, use minimal force to insert a digital card.

📄 **NOTE:** The SD Card Reader is located on the left edge of the Slate.

1. Hold the digital card label-side up, with the connectors toward the Slate.
2. Insert the card into the SD Card Reader, and then push in on the card until it is firmly seated.

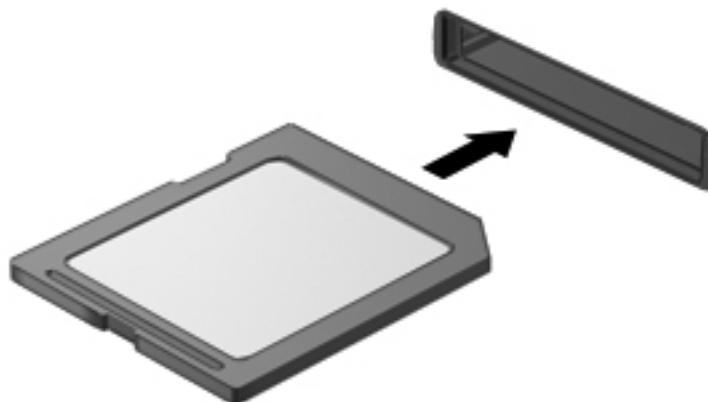

You will hear a sound when the device has been detected, and a menu of options may be displayed.

Removing a digital card

△ **CAUTION:** To prevent loss of information or an unresponsive system, use the following procedure to safely remove the digital card.

📄 **NOTE:** The SD Card Reader is located on the left edge of the Slate.

1. Save your information and close all programs associated with the digital card.
2. Tap the remove hardware icon in the notification area, at the far right of the taskbar, and then follow the on-screen instructions.
3. Press in on the digital card **(1)**, and then remove it from the slot **(2)**.

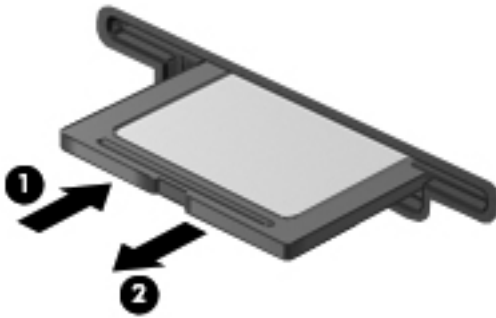

Using a USB device

Universal Serial Bus (USB) is a hardware interface that can be used to connect an optional external device, such as a USB keyboard, mouse, drive, printer, scanner, or hub, to the system.

Some USB devices may require additional support software, which is usually included with the device. For more information about device-specific software, refer to the manufacturer's instructions.

The Slate has a USB port, which supports USB 1.0, USB 1.1, or 2.0 devices. An HP Slate Dock or USB hub provides additional USB ports that can be used with the Slate.

Connecting a USB device

△ **CAUTION:** To reduce the risk of damage to a USB connector, use minimal force to connect the device.

- ▲ Connect the USB cable for the device to the USB port.



You will hear a sound when the device has been detected.

 **NOTE:** The first time you connect a USB device, a message in the notification area lets you know that the device is recognized by the Slate.

Removing a USB device

△ **CAUTION:** To reduce the risk of damage to a USB connector, do not pull on the cable to remove the USB device.

CAUTION: To prevent loss of information or an unresponsive system, use the following procedure to safely remove a USB device.

1. Save your information and close all programs associated with the device.
2. Tap the remove hardware icon in the notification area, at the far right of the taskbar, and then follow the on-screen instructions.
3. Remove the device.

7 Drives

Identifying installed drives

To view the drives installed on the Slate, tap **Start > Computer**.

Handling optional external hard drives

Optional external hard drives are fragile computer components that must be handled with care. Refer to the following cautions before handling drives. Additional cautions are included with the procedures to which they apply.

-
- △ **CAUTION:** To reduce the risk of damage to the Slate, damage to a drive, or loss of information, observe these precautions:

Before you move a Slate that is connected to an external hard drive, initiate Sleep and allow the screen to clear, or properly disconnect the external hard drive.

Before handling a drive, discharge static electricity by touching the unpainted metal surface of the drive.

Do not touch the connector pins on a removable drive or on the Slate.

Handle a drive carefully; do not drop a drive or place items on it.

Before removing or inserting a drive, shut down the Slate. If you are unsure whether the Slate is off, in the Sleep state, or in Hibernation, turn the Slate on and then shut it down through the operating system.

When the battery is the only source of power, be sure that the battery is sufficiently charged before writing to media.

Avoid exposing a drive to temperature or humidity extremes.

Avoid exposing a drive to liquids. Do not spray the drive with cleaning products.

Remove media from a drive before removing the drive from the drive bay, or traveling with, shipping, or storing a drive.

If a drive must be mailed, place the drive in a bubble-pack mailer or other suitable protective packaging and label the package "FRAGILE."

Avoid exposing a drive to magnetic fields. Security devices with magnetic fields include airport walk-through devices and security wands. The airport security devices that check carry-on luggage, such as conveyor belts, use X-rays instead of magnetism and will not damage a drive.

Using optional external drives

Removable external drives expand your options for storing and accessing information.

USB drives include the following types:

- 1.44-megabyte diskette drive
- Hard drive module (a hard drive with an adapter attached)
- DVD-ROM Drive
- DVD/CD-RW Combo Drive
- DVD+RW/R and CD-RW Combo Drive
- DVD±RW/R and CD-RW Combo Drive

Using optional external devices

 **NOTE:** For more information about required software and drivers, or to learn which device port to use, refer to the manufacturer's instructions.

NOTE: To use an external optical disc drive connected to the Slate, you must connect AC power separately to the external drive.

To connect an external device:

 **CAUTION:** To reduce the risk of damage to the equipment when connecting a powered device, be sure that the Slate is turned off and the AC power cord is unplugged.

1. Connect the device to the Slate.
2. If you are connecting a powered device, plug the device power cord into a grounded AC outlet.
3. Turn on the Slate.

To disconnect an unpowered external device, turn off the Slate, and then disconnect it. To disconnect a powered external device, turn off the Slate, disconnect it, and then unplug the AC power cord.

8 Security

Protecting your Slate

Standard security features provided by the Windows operating system and the non-Windows BIOS Setup can protect your personal settings and data from a variety of risks.

Follow the procedures in this chapter to use the following features:

- Passwords
- Antivirus software (purchased separately)
- Firewall software
- Critical security updates

 **NOTE:** Security solutions are designed to act as deterrents. These deterrents may not prevent the Slate from being mishandled or stolen.

NOTE: Before you send your Slate for service, remove all password settings.

NOTE: Some features listed in this chapter may not be available on your Slate.

Computer risk	Security feature
Unauthorized access to data	<ul style="list-style-type: none">• Firewall software• Windows updates
Ongoing or future threats to the Slate	Critical security updates from Microsoft

Using passwords

A password is a group of characters that you choose to secure your Slate's information. Several types of passwords can be set, depending on how you want to control access to your information. Passwords can be set in Windows or in the non-Windows BIOS Setup preinstalled on the Slate.

△ **CAUTION:** To avoid being locked out of the Slate, record each password you set. Because most passwords are not displayed as they are set, changed, or deleted, it is essential to record each password immediately and store it in a secure place.

You can use the same password for a BIOS Setup feature and for a Windows security feature. You can also use the same password for more than one BIOS Setup feature.

Use the following guidelines when setting a password in BIOS Setup:

- A password can be any combination of up to 8 letters and numbers and is case sensitive.
- A password set in BIOS Setup must be entered at a BIOS Setup prompt. A password set in Windows must be entered at a Windows prompt.

Use the following tips for creating and saving passwords:

- When creating passwords, follow requirements set by the program.
- Write down your passwords and store them in a secure place away from the Slate.
- Do not store passwords in a file on the Slate.
- Do not use your name or other personal information that could be easily discovered by an outsider.

For additional information about Windows passwords, such as screen-saver passwords, tap **Start > Help and Support**.

Using antivirus software

When you use the Slate for e-mail or Internet access, you expose it to computer viruses that can disable the operating system, programs, or utilities or cause them to function abnormally.

Antivirus software (purchased separately) can detect most viruses, destroy them, and in most cases, repair damage they have caused. To provide ongoing protection against newly discovered viruses, antivirus software must be kept up to date.



NOTE: HP recommends that you always update the antivirus software to help protect your Slate.

NOTE: For more information about computer viruses, type `viruses` in the Search box in Help and Support.

Using firewall software

When you use the Slate for e-mail, network, or Internet access, unauthorized persons may be able to gain access to the Slate, your personal files, and information about you. Use the firewall software preinstalled on the Slate to protect your privacy.

Firewall features include logging and reporting of network activity, and automatic monitoring of all incoming and outgoing traffic. Refer to the firewall user guide or contact your firewall manufacturer for more information.

 **NOTE:** Under some circumstances a firewall can block access to Internet games, interfere with printer or file sharing on a network, or block authorized e-mail attachments. To temporarily resolve the problem, disable the firewall, perform the task that you want to perform, and then reenable the firewall. To permanently resolve the problem, reconfigure the firewall.

Installing critical updates

△ **CAUTION:** Microsoft sends alerts regarding critical updates. To protect the Slate from security breaches and computer viruses, install all critical updates from Microsoft as soon as you receive an alert.

Updates to the operating system and other software may have become available after the Slate was shipped. To be sure that all available updates are installed on the Slate, observe these guidelines:

- Run Windows Update as soon as possible after you set up your Slate. Tap **Start > All Programs > Windows Update**.
- Run Windows Update at regular intervals, such as once a month.
- Obtain updates to Windows and other Microsoft programs, as they are released, from the Microsoft Web site and through the **Check for updates for your computer** link in Windows Update.

9 Updating software

To update the software, follow these steps, which are explained in the remainder of this guide:

1. Identify your Slate's model, product category, and series or family. Prepare for a system BIOS update by identifying the BIOS version currently installed on the Slate.

If your Slate is connected to a network, consult the network administrator before installing any software updates, especially system BIOS updates.

 **NOTE:** The Slate's system BIOS is stored on the system ROM. The BIOS initializes the operating system, determines how the Slate will interact with the hardware devices, and provides for data transfer among hardware devices, including the time and date.

2. Access the updates on the HP Web site at <http://www.hp.com>.
3. Install the updates.

Updating programs and drivers

To download and install software other than a BIOS update, follow these steps:

1. Access the updates on the HP Web site at <http://www.hp.com>.
2. Follow the instructions on the screen to find the software you want to update.
3. At the download area, tap the software you want to download and follow the instructions on the screen.

 **NOTE:** Make a note of the path to the location on your hard drive where the software is to be downloaded. You will need to access this path when you are ready to install the software.

4. When the download is complete, open Windows Explorer by tapping **Start > Computer**.
5. Double-tap your hard drive designation. The hard drive designation is typically Local Disk (C:).
6. Using the hard drive path you recorded earlier, open the folder on your hard drive that contains the update.
7. Double-tap the file that has an .exe extension (for example, *filename.exe*).

The installation begins.

8. Complete the installation by following the instructions on the screen.

 **NOTE:** After a message on the screen reports a successful installation, you can delete the downloaded file from your hard drive.

10 BIOS Setup

Starting BIOS Setup

BIOS Setup is a ROM-based information and customization utility that can be used even when your Windows operating system is not working.

The utility reports information about the Slate and provides settings for startup, security, and other preferences.

To start BIOS Setup:

 **NOTE:** An external keyboard may be connected to the USB port to perform these steps.

1. Open the Startup Menu by turning on or restarting the Slate, and then, while the hyphen is displayed in the upper-left corner of the screen, repeatedly pressing the Volume down button (-) on the Slate or **f10** on an external keyboard.
2. Press the Volume down button (-) on the Slate to advance to **BIOS Setup**, and then select it by pressing the Home button on the Slate or **enter** on an external keyboard.

Using BIOS Setup

Changing the language of BIOS Setup

The following procedure explains how to change the language of BIOS Setup. If BIOS Setup is not already running, begin at step 1. If BIOS Setup is already running, begin at step 3.

 **NOTE:** An external keyboard may be connected to the USB port to perform these steps.

1. Open the Startup Menu by turning on or restarting the Slate, and then, while the hyphen is displayed in the upper-left corner of the screen, repeatedly pressing the Volume down button (-) on the Slate or **f10** on an external keyboard.
2. Press the Volume down button (-) on the Slate, or use the arrow keys on an external keyboard to advance to **BIOS Setup**, and then select it by pressing the Home button on the Slate or **enter** on an external keyboard.
3. Press the Volume up button (+) or the Volume down button (-) on the Slate, or use the arrow keys on an external keyboard to select **System Configuration > Language**, and then press the Home button on the Slate or **enter** on an external keyboard.

4. Press the Volume up button (+) or Volume down button (-) on the Slate or the arrow keys on an external keyboard to select a language, and then press the Home button on the Slate or **enter** on an external keyboard.
5. To save your changes and exit BIOS Setup, press the Ctrl+alt+del button on the top edge of the Slate, or use the arrow keys on an external keyboard to select **Exit > Exit Saving Changes**. Then press the Home button on the Slate or **enter** on an external keyboard.

Your change goes into effect immediately.

Navigating and selecting in BIOS Setup

Because BIOS Setup is not Windows based, it does not support the touch screen. Navigation and selection are by keystroke.

 **NOTE:** An external keyboard may be connected to the USB port to perform these steps.

- To choose a menu or a menu item, press the Home button on the Slate, or use the arrow keys on an external keyboard.
- To navigate between menus in BIOS Setup, press the Home button and the Volume up (+) or Volume down (-) button simultaneously, or use the arrow keys on an external keyboard.
- To choose an item in a list or to toggle a field, for example an Enable/Disable field, use either the Home button, the Volume up button, or the Volume down button on the Slate, or the arrow keys on an external keyboard.
- To select an item, press the Home button on the Slate or the **enter** key on an external keyboard.
- To close a text box or return to the menu display, press the Ctrl+alt+del (Security) button on the top edge of the Slate or **esc** on an external keyboard.
- Information about navigation keys is displayed at the bottom of the screen. To display additional navigation and selection information while BIOS Setup is open, press **f1** on an external keyboard.

Displaying system information

The following procedure explains how to display system information in BIOS Setup. If BIOS Setup is not open, begin at step 1. If BIOS Setup is open, begin at step 3.

 **NOTE:** An external keyboard may be connected to the USB port to perform these steps.

1. Open the Startup Menu by turning on or restarting the Slate, and then, while the hyphen is displayed in the upper-left corner of the screen, repeatedly pressing the Volume down button (-) on the Slate or **f10** on an external keyboard.
2. Press the Volume down button (-) on the Slate, or use the arrow keys on an external keyboard, to advance to **BIOS Setup**, and then select it by pressing the Home button on the Slate or **enter** on an external keyboard.
3. If BIOS Setup does not open with the system information displayed, press the Home button and the Volume up button (+) on the Slate simultaneously, or use the arrow keys on an external keyboard, to select the **Main** menu.

When the Main menu is selected, system information is displayed.

4. To exit BIOS Setup without changing any settings, press the Ctrl+alt+del (Security) button on the top edge of the Slate or the arrow keys on an external keyboard to select **Exit > Exit Discarding Changes**. Then press the Home button on the Slate or the **enter** key on an external keyboard.

Restoring factory settings in BIOS Setup

The following procedure explains how to restore the BIOS Setup factory settings. If BIOS Setup is not already running, begin at step 1. If BIOS Setup is already running, begin at step 3.

 **NOTE:** An external keyboard may be connected to the USB port to perform these steps.

1. Open the Startup Menu by turning on or restarting the Slate, and then, while the hyphen is displayed in the upper-left corner of the screen, repeatedly pressing the Volume down button (-) on the Slate or **f10** on an external keyboard.
2. Press the Volume down button (-) on the Slate, or use the arrow keys on an external keyboard, to advance to **BIOS Setup**, and then select it by pressing the Home button on the Slate or **enter** on an external keyboard.
3. Press the Home button and the Volume up button (+) on the Slate simultaneously or the arrow keys on an external keyboard to select **Exit > Load Setup Defaults**. Then press the Home button on the Slate or the **enter** key on an external keyboard.
4. When the Setup Confirmation is displayed, press the Home button on the Slate or the **enter** key on an external keyboard.
5. To save your changes and exit BIOS Setup, press the Ctrl+alt+del (Security) button on the top edge of the Slate, or use the arrow keys on an external keyboard, to select **Exit > Exit Saving Changes**. Then press the Home button on the Slate or the **enter** key on an external keyboard.

The BIOS Setup factory settings go into effect when the Slate restarts.

 **NOTE:** Your password, security, and language settings are not changed when you restore the factory default settings.

Exiting BIOS Setup

You can exit BIOS Setup with or without saving changes.

 **NOTE:** An external keyboard may be connected to the USB port to perform these steps.

- To exit BIOS Setup and save your changes from the current session:

Press the Ctrl+alt+del (Security) button on the top edge of the Slate, or use the arrow keys on an external keyboard, to select **Exit > Exit Saving Changes**. Then press the Home button on the Slate or the **enter** key on an external keyboard.

- To exit BIOS Setup without saving your changes from the current session:

Press the Ctrl+alt+del (Security) button on the top edge of the Slate, or use the arrow keys on an external keyboard, to select **Exit > Exit Discarding Changes**. Then press the Home button on the Slate or the **enter** key on an external keyboard.

After either choice, the Slate restarts in Windows.

Updating the BIOS

Updated versions of the software provided with your Slate may be available on the HP Web site.

Most BIOS updates on the HP Web site are packaged in compressed files called *SoftPaqs*.

Some download packages contain a file named *Readme.txt*, which contains information regarding installing and troubleshooting the file.

Determining the BIOS version

To determine whether available BIOS updates contain later BIOS versions than those currently installed on the Slate, you need to know the version of the system BIOS currently installed.

BIOS version information (also known as *ROM date* and *System BIOS*) can be displayed by opening BIOS Setup.

To display the BIOS information:

 **NOTE:** An external keyboard may be connected to the USB port to perform these steps.

1. Open the Startup Menu by turning on or restarting the Slate, and then, while the hyphen is displayed in the upper-left corner of the screen, repeatedly pressing the Volume down button (-) on the Slate or **f10** on an external keyboard.
2. Press the Volume down button (-) on the Slate, or use the arrow keys on an external keyboard, to advance to **BIOS Setup**, and then select it by pressing the Home button on the Slate or **enter** on an external keyboard.
3. If BIOS Setup does not open with the system information displayed, press the Home button and the Volume up button (+) on the Slate simultaneously, or use the arrow keys on an external keyboard, to select the **Main** menu.

When the Main menu is selected, BIOS and other system information is displayed.

4. To exit BIOS Setup without saving your changes from the current session:

Press the **Ctrl+alt+del** (Security) button on the top edge of the Slate, or use the arrow keys on an external keyboard, to select **Exit > Exit Discarding Changes**. Then press the Home button on the Slate or the **enter** key on an external keyboard.

Downloading a BIOS update

 **CAUTION:** To reduce the risk of damage to the Slate or an unsuccessful installation, download and install a BIOS update only when the Slate is connected to reliable external power using the AC adapter. Do not download or install a BIOS update while the Slate is running on battery power, docked in an optional docking device, or connected to an optional power source. During the download and installation, follow these instructions:

Do not disconnect power from the Slate by unplugging the power cord from the AC outlet.

Do not shut down the Slate or initiate Sleep or Hibernation.

Do not insert, remove, connect, or disconnect any device, cable, or cord.

To download a BIOS update:

1. Access the updates on the HP Web site at <http://www.hp.com>.
2. Follow the on-screen instructions to identify your Slate and access the BIOS update you want to download.
3. At the download area, follow these steps:
 - a. Identify the BIOS update that is later than the BIOS version currently installed on your Slate. Make a note of the date, name, or other identifier. You may need this information to locate the update later, after it has been downloaded to your hard drive.
 - b. Follow the instructions on the screen to download your selection to the hard drive.

Make a note of the path to the location on your hard drive where the BIOS update is to be downloaded. You will need to access this path when you are ready to install the update.

 **NOTE:** If you connect your Slate to a network, consult the network administrator before installing any software updates, especially system BIOS updates.

BIOS installation procedures vary. Follow any instructions that are displayed on the screen after the download is complete. If no instructions are displayed, follow these steps:

1. Open Windows Explorer by tapping **Start > Computer**.
2. Double-tap your hard drive designation. The hard drive designation is typically Local Disk (C:).
3. Using the hard drive path you recorded earlier, open the folder on your hard drive that contains the update.
4. Double-tap the file that has an .exe extension (for example, *filename.exe*).

The BIOS installation begins.

5. Complete the installation by following the instructions on the screen.

 **NOTE:** After a message on the screen reports a successful installation, you can delete the downloaded file from your hard drive.

BIOS Setup Menu

The tables in this section provide an overview of the BIOS Setup menu options.

 **NOTE:** Some of the BIOS Setup menu items listed in this chapter may not be supported by your Slate.

Main menu

Select	To do this
System information	<ul style="list-style-type: none">• View and change the system time and date.• View identification information about the Slate.• View specification information about the processor, memory size, and system BIOS.

Diagnostics menu

Select	To do this
Primary Hard Disk Self Test	Run a quick or comprehensive self-test on the hard drive.
Memory Test	Run a diagnostic test on the system memory.

System Configuration menu

Select	To do this
Language	Change the display language for BIOS Setup.
Virtualization Technology	Enable or disable. HP recommends that this feature remain disabled unless specialized applications are being used.
USB Legacy	Enable or disable a USB keyboard, disk, or drive to be used in BIOS Setup.
Processor deeper power saving states	Enable or disable.
Boot Options	<ul style="list-style-type: none">• POST HotKey Delay—Select 0, 5, 10, 15, or 20 seconds to allow more time to press a hotkey to enter BIOS Setup when the Slate restarts.• Boot Order options —Select the order in which the Slate searches for a boot disk.

Index

- A**
 - AC adapter
 - connecting 33
 - identifying 17
 - airport security devices 39
 - antennas 16
 - audio functions, checking 26
 - audio-in (microphone) jack 12, 24
 - audio-out (headphone) jack 12, 24
- B**
 - battery
 - discharging 32
 - low battery levels 32
 - power 31
 - BIOS Setup Menu 52
 - BIOS, updating 51
 - Bluetooth device 19
 - boot options 53
 - boot order 53
 - buttons
 - Ctrl+alt+del 14
 - Home 11, 14
 - Keyboard 14
 - volume 14, 15
 - Volume down 11
 - Volume up 11
- C**
 - cables, USB 38
 - camera 27
 - camera, identifying 15, 16, 23
 - changing BIOS Setup
 - language 48
 - checking audio functions 26
 - components
 - additional hardware 17
 - bottom edge 12
 - display 15
 - left edge 14
 - rear 16
 - right edge 12
 - top edge 11
 - connecting to a WLAN 20
 - connection, external power 33
 - connector, power 12
 - cord, power 17
 - corporate WLAN connection 20
 - creating a wireless connection 19
 - critical battery level 32
 - Ctrl+alt+del button, identifying 11, 14
- D**
 - Diagnostics menu 53
 - digital card
 - inserting 36
 - removing 37
 - digital pen, using 7
 - displaying system information 49
 - dragging touch screen gesture 3
 - drive media 29
 - drives
 - boot order 53
 - external 40
 - hard 40
- E**
 - earbuds 12, 24
 - encryption 21
 - exiting BIOS Setup 50
 - external drive 40
- F**
 - finding more information 2
 - firewall 21
 - flicking touch screen gesture 3
- flicks**
 - changing assignments 6
 - creating assignments 6
- H**
 - hard drive
 - external 40
 - self test 53
 - hardware, identifying 11
 - headphone (audio-out) jack 12, 24
 - headphones 12, 24
 - Hibernation
 - exiting 29
 - initiated during critical battery level 32
 - initiating 29
 - Home button 11, 14
 - HP Slate Dock 35
 - hubs 37
- I**
 - icons
 - network 19
 - wireless 19
 - Internet connection setup 20
- J**
 - jacks
 - audio-in (microphone) 12, 24
 - audio-out (headphone) 12, 24
- K**
 - keyboard 6
 - Keyboard button 14, 15

L

- label tray
 - identifying 12
 - opening 13
- labels
 - Microsoft Certificate of Authenticity 18
 - regulatory 18
 - serial number 17
- landscape view 9
- language 53
- light, power 12
- low battery level 32

M

- Main menu 52
- memory test 53
- microphone (audio-in) jack 12, 24
- microphone, identifying 14
- multimedia components, identifying 23

N

- navigating in BIOS Setup 49
- network icon 19

O

- on-screen keyboard
 - options 7
 - using 6
- operating system 28
- operating system controls 19
- orientation, changing 9

P

- pen, using 7
- pinching touch screen gesture 5
- portrait view 9
- ports, USB 11, 37
- power cord, identifying 17
- power light, identifying 12
- power switch, identifying 13
- power, connecting 33
- PowerLock 13
- processor deeper power saving states 53
- product name and number, Slate 17
- programs, updating 47
- public WLAN connection 20

R

- readable media 29
- regulatory information, regulatory label 18
- restoring default settings 50
- rotating touch screen gesture 4

S

- scrolling touch screen gesture 4
- SD Card Reader, identifying 14
- security, wireless 21
- selecting in BIOS Setup 49
- serial number, Slate 17
- setup 11
- setup, WLAN 20
- shutdown 28
- Sleep
 - exiting 29
 - initiating 29
- software
 - HP Slate Camera 27
- speakers 12, 24
- switch, power 13
- System Configuration menu 53
- system information 52

T

- tapping touch screen gesture 3
- touch screen
 - performing screen actions 5
 - preferences 5
 - using 3
- touch screen gestures
 - dragging 3
 - flicking 3
 - pinching 5
 - rotating 4
 - scrolling 4
 - tapping 3
 - zooming 5
- turning off the Slate 28

U

- unresponsive system 28
- USB cable, connecting 38
- USB devices
 - connecting 37
 - description 37
 - removing 38
- USB hubs 37
- USB ports, identifying 11, 37

V

- view, changing 9
- volume buttons, identifying 14, 15
- Volume down button 11
- Volume up button 11
- volume, adjusting 25

W

- wireless antennas 16
- wireless connection, creating 19
- wireless icon 19
- wireless network (WLAN)
 - connecting 20
 - corporate WLAN connection 20
 - equipment needed 20
 - functional range 20
 - public WLAN connection 20
 - security 21
- WLAN antennas, identifying 16
- writable media 29

Z

- zooming screen gesture 5

